

TONE® SHEAR WRENCH

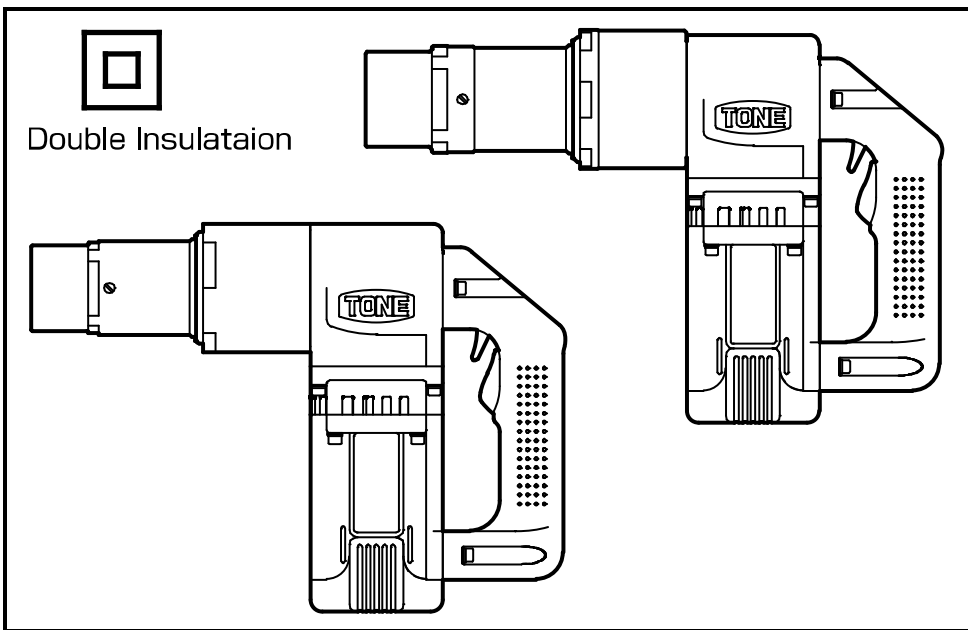

INSTRUCTION MANUAL **No.1311**

MODEL	GS-91EZ / GS-92EZ GS-111EZ / GS-112EZ
-------	--



CAUTION

Read and fully understand all the instructions before use.
Keep this manual in designated place for easy and quick reference.
The models mentioned on this manual are designed for use outside Japan.
Warranty shall be void if above mentioned models are use in Japan.

TONE CO., LTD.

PREFACE

Thank you for purchasing **SHEAR WRENCH**.

- Upon receipt, check and confirm the following:
 - Check any transport damages.
 - Check for any loose or lost screws and bolts.
 - Check the model as per order.
 - Check all the accessories are contained.

If any problems are found, contact your distributor.

- Read this instruction manual carefully before use.
Full understanding of manual is essential to prevent personal injury or malfunction.
- Keep this manual in a bag attached to the back of metal case lid for easy and quick reference.
- If manual or warning label is lost or becomes illegible, or if additional manual is required, contact your distributor.

If you have any questions about the products or the contents of this instruction manual, contact your distributor.



- This manual is only applicable to outside Japan.

SAFETY INSTRUCTION

This manual specifies three (3) basic safety instructions:



- Instructions are classified by degree of risk and described as follows:

	Danger is used to indicate threatening dangerous or unsafe practices which could immediately result in severe personal injury or death in the worst case.
	Warning is used to indicate hazardous or unsafe practices which could result in severe personal injury or death in the worst occasion.
	Caution is used to indicate hazardous or unsafe practices which could result in personal injury or product or property damage.

Even if the risk is classified as  , risk could become more serious result depending on conditions. Make sure to follow all instructions when using.

TABLE OF CONTENTS

1. GENERAL SAFETY INSTRUCTIONS	4
2. APPLICATION	7
3.  PRECAUTIONS FOR USE	7
4. PART NAME	13
5. FEATURES	14
6. BEFORE USE	14
7. OPERATING PROCEDURE	15
8. CHANGING SOCKET	17
9. INSPECTION & MAINTENANCE	19
10. SPECIFICATIONS	21
11. AFTERSALES SERVICE	22

1. GENERAL SAFETY INSTRUCTIONS



WARNING

When using electric tools, basic safety precautions, including the following, should always be followed to reduce the risk of fire, electric shock and personal injury. Read all these instructions before operating this product and keep these instructions.

SAVE THESE INSTRUCTIONS

1) Work area

- a) Keep work area clean and well lit. Cluttered and dark areas invite accidents.
- b) Do not operate power tools in explosive atmospheres, such as in the presence of flammable liquids, gases or dust. Power tools create sparks which may ignite the dust or fumes.
- c) Keep children and bystanders away while operating a power tool. Distractions can cause you to lose control.

2) Electrical safety

- a) Power tool plugs must match the outlet. Never modify the plug in any way. Do not use any adapter plugs with earthed (grounded) power tools. Unmodified plugs and matching outlets will reduce risk of electric shock.
- b) Avoid body contact with earthed or grounded surfaces such as pipes, radiators, ranges and refrigerators. There is an increased risk of electric shock if your body is earthed or grounded.
- c) Do not expose power tools to rain or wet conditions. Water entering a power tool will increase the risk of electric shock.
- d) Do not abuse the cord. Never use the cord for carrying, pulling or unplugging the power tool. Keep cord away from heat, oil, sharp edges or moving parts. Damaged or entangled cords increase the risk of electric shock.

- e) When operating a power tool outdoors, use an extension cord suitable for outdoor use. Use of a cord suitable for outdoor use reduces the risk of electric shock.

3) Personal safety

- a) Stay alert, watch what you are doing and use common sense when operating a power tool. Do not use a power tool while you are tired or under the influence of drugs, alcohol or medication. A moment of inattention while operating power tools may result in serious personal injury.
- b) Use safety equipment. Always wear eye protection. Safety equipment such as dust mask, non-skid safety shoes, hard hat, or hearing protection used for appropriate conditions will reduce personal injuries.
- c) Avoid accidental starting. Ensure the switch is in the off position before plugging in. Carrying power tools with your finger on the switch or plugging in power tools that have the switch on invites accidents.
- d) Remove any adjusting key or wrench before turning the power tool on. A wrench or a key left attached to a rotating part of the power tool may result in personal injury.
- e) Do not overreach. Keep proper footing and balance at all times. This enables better control of the power tool in unexpected situations.
- f) Dress properly. Do not wear loose clothing or jewelry. Keep your hair, clothing and gloves away from moving parts. Loose clothes, jewelry or long hair can be caught in moving parts.
- g) If devices are provided for the connection of dust extraction and collection facilities, ensure these are connected and properly used. Use of these devices can reduce dust related hazards.

4) Power tool use and care

- a) Do not force the power tool. Use the correct power tool for your application. The correct power tool will do the job better and safer at the rate for which it was designed.
- b) Do not use the power tool if the switch does not turn it on and off. Any power tool that cannot be controlled with the switch is dangerous and must be repaired.
- c) Disconnect the plug from the power source before making any adjustments, changing accessories, or storing power tools. Such preventive safety measures reduce the risk of starting the power tool accidentally.
- d) Store idle power tools out of the reach of children and do not allow persons unfamiliar with the power tool or these instructions to operate the power tool. Power tools are dangerous in the hands of untrained users.
- e) Maintain power tools. Check for misalignment or binding of moving parts, breakage of parts and any other condition that may affect the power tools operation. If damaged, have the power tool repaired before use. Many accidents are caused by poorly maintained power tools.
- f) Keep cutting tools sharp and clean. Properly maintained cutting tools with sharp cutting edges are less likely to bind and are easier to control.
- g) Use the power tool, accessories and tool bits etc., in accordance with these instructions and in the manner intended for the particular type of power tool, taking into account the working conditions and the work to be performed. Use of the power tool for operations different from intended could result in a hazardous situation.

5) Service

- a) Have your power tool serviced by a qualified repair person using only identical replacement parts. This will ensure that the safety of the power tool is maintained.

2. APPLICATION

- **SHEAR WRENCH** is an electric tool for tightening Tension Control Bolt/Nut/Washer assemblies.

3. PRECAUTIONS FOR USE

- To prevent accidents, personal injury and etc, read and follow all instructions listed below.

DANGER

- Beware of electric shock when operating at high place.
 - Failure to follow this instruction may result in fall down accidents.

— About Double Insulation —

This electric wrench has double insulation structure. An electric conductor portion is insulated by two insulators which enhances safety against electric shock. The electric wrenches that have double insulated structure are clearly marked with  (Double Insulation Mark) on the rating plate.



WARNING

● Beware of electric shock.

- Never use the wrench under rainy or snowy condition.
- Never touch the plug with wet hands.

Failure to follow this instruction may result in electric shock, fire or electric leakage.

● Electric cord must be regularly inspected.

- Stop using the wrench if there is a problem with the electric cord.
- Contact your distributor for repair.

Failure to follow this instruction may result in electric shock or electric leakage.

● Never use the wrench around the place where gasoline, gas, thinner, benzene, etc., are stored.

- Do not use the wrench around flammable substances to avoid the accidental fire caused by the spark out of the electric motor.

● Beware of fall down accidents when working at a high place.

- Wear safety belt
- Provide safety net or canvas as safe guarding against falling items.
- Confirm that no one is underneath the working site before operation.
- Stop operation when physically or mentally tired.

Failure to follow these instructions may result in fall down accidents.

● Avoid overloading.

- Use the wrench and its accessories within the rated specifications. Overloaded wrench and its accessories may result in malfunction of the wrenches, accidents or personal injury.

 **WARNING**

● **Properly install bar sockets as described in this manual.**

- Incomplete installation may result in accidents and personal injury. See “CHANGING SOCKETS” on page 17.

● **Avoid accidental Starting.**

- Ensure that the switch is in the off-position before plugging into power source.
- Never carrying the wrench with your fingers on the switch when the plug is connected to power source.

● **Disconnect the plug from the power source when:**

- Not in use.
- Changing accessories.
- Inspection and maintenance.
- Or other danger is foreseen.

Failure to follow these instructions may result in accidental starting and personal injury.

● **Do not disassemble or modify the wrench.**

- Disassembly or modification made by unauthorized personnel may result in malfunction or personal injury.
- Disassembly & Re-assembly work is permitted for the following expendables: Inner Socket, Outer Socket, Set Screws, Inner Socket Spring, Ejector Pin, Ejector Spring and Carbon Brushes.

● **Store wrench in the metal case and keep it at the designated place when not in use.**

- Store wrench in lockable dry location to keep any unauthorized personnel away.

Failure to follow this instruction may result in malfunction or accidents.

 **WARNING**

- **Immediately stop using the wrench and disconnect the plug when unusual sound, vibration or smell is detected.**

- Contact your distributor immediately.

Failure to follow this instruction may result in serious injury.

- **Contact your distributor for repair service.**

- Repair work should only be carried out by a qualified serviceman.

- Repair work done by an inexperienced person may cause accidents, injury or malfunction.

- **Check the following items before operation.**

- Check for any deformation, crack or damage on the wrench body, sockets, electric cord, plug and etc.

- Do not use the wrench if any problem are found on items listed above.

- Make sure that socket assembly is correctly installed on the wrench.

- Make sure that set screws are securely fastened. Loose installation may result in accidents and personal injury.

- **Use appropriate power source as indicated on the rating plate.**

Failure to follow this instruction may result in fire or burn accidents.

- **Immediately check the wrench when it is dropped down or banged.**

- Check for deformation, crack, damage and other abnormality. Stop using the wrench if any abnormality is found.

Continued use of fault wrench may result in accidents and personal injury.

 **CAUTION**

- **Keep work area clean.**
 - Cluttered areas and benches invite accidents.
- **Keep children away.**
 - Do not let children touch the wrench and electric cord.
 - All visitors should be kept away from work area.
- **Secure work area.**
 - Keep body stance balanced and firmed.
 - Never wrap the electric cord around something.
 - Keep work area well lit.
- **Use suitable model for each application.**
 - Do not use wrench beyond its rated specifications.
 - Do not use wrench for purpose not intended.
- **Dress properly.**
 - Always wear gloves and non-skid footwear when operating outdoor.
 - Always wear safety helmet.
- **Use genuine accessories or attachments manufactured by Maeda Metal Industries, Ltd.**
- **Do not connect multiple plugs to a single outlet by using multiple outlet adaptors.**
 - Over current may cause fire, accidents or malfunction.
- **Do not abuse the electric cord.**
 - Never use the electric cord for carrying, pulling, or unplugging the power.
 - Keep the electric cord away from heat, oil, sharp edges or moving parts.

 **CAUTION**

- **Keep electric motor well ventilated.**
 - Do not put any foreign materials into the vent.
 - Do not block exhaust vent.
- **Maintain wrench.**
 - Keep wrench handle clean, dry and free of oil or grease.
- **Provide leakage breaker as a shock guard for each wrench.**
 - Although double insulated wrench does not require leakage breaker, use of leakage breaker is strongly recommended as an extra safeguard.
- **When applying extension cord, select shorter extension units than specified below depending on the cross section.**

Nominal conducting cable cross section		Max. Length	
		110-120V	220-230V
H07RN-F	1.25mm ²	10m	20m
	2.0mm ²	20m	40m
	3.5mm ²	30m	60m
AWG 14		50ft	100ft
AWG 12		80ft	160ft
AWG 10		130ft	260ft

- Using extension cord more than Maximum Length may result in malfunction or breakdown due to performance drop of the wrench.
- **Use attached connector when using extension cord.**
- **Observe local laws and rules concerning noise level.**

4. PART NAME

(Figure 1)

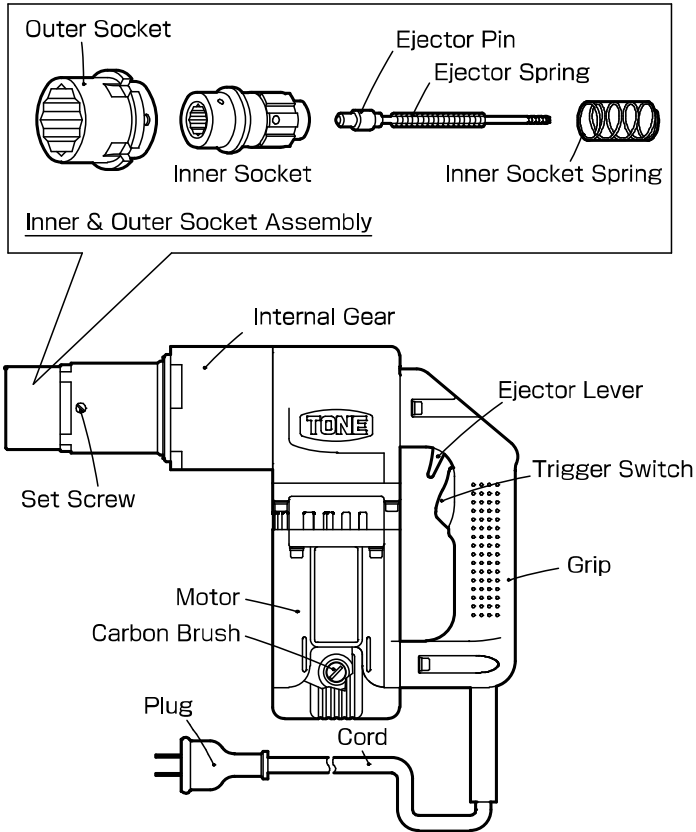

MODEL	ACCESSORIES
GS-91EZ	Inner Socket
GS-92EZ	Outer Socket
GS-111EZ	Inner Socket Spring
GS-112EZ	Ejector Pin
	Ejector Spring
	Screwdriver (-)
	Instruction Manual

● Contact your distributor for other available sockets and accessories.

5. FEATURES

- All New Design Aluminum Double Insulated Motor.
- Anti-defacement Mechanism Inner Socket.

6. BEFORE USE

WARNING

● **Check followings before connecting the plug into power source.**

- Accidental starting invites personal injury.

1. Check for any deformation, crack or damage on wrench body, socket, electric cord, etc.

Do not use wrench if any problem is found on items listed above.

2. Make sure to use commercial power supply.

Use appropriate power source as indicated on the rating plate.

3. Make sure that socket assembly is correctly installed on the wrench.

4. Make sure that set screws are securely fastened.

Loose installation may result in accidents and personal injury.

See “CHANGING SOCKETS” on page 17.

7. OPERATING PROCEDURE

CAUTION

- Snug tight using snug tightening wrench like SNUG MASTER is required before using SHEAR WRENCH.

(1) Slide Inner Socket over the bolt pintail (Figure 2).

(Figure 2)

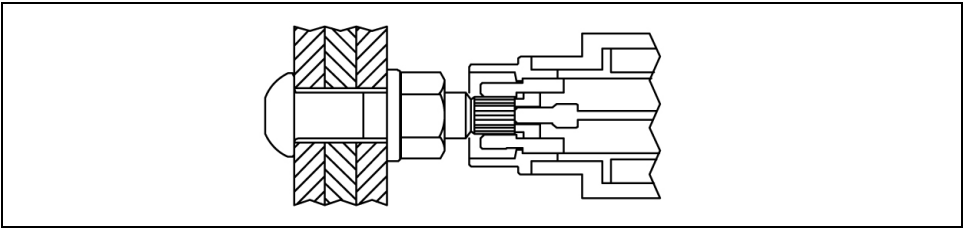

(2) Slide Outer Socket over the nut (Figure 3).

- Slightly turn Internal Gear when slide over is difficult.
- Outer Socket can not be engaged on the nut when Anti defacement mechanism of the Inner Socket detects improper Inner Socket engagement. In such case, back to step (1) and slide the Inner Socket over the bolt pintail completely.

(Figure 3)

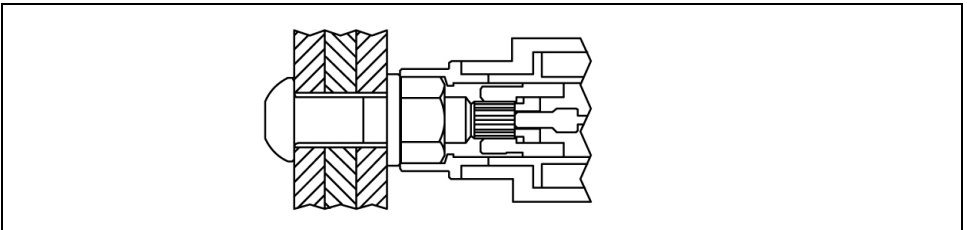

(3) Squeeze trigger switch to start tightening (Figure 4).

(Figure 4)

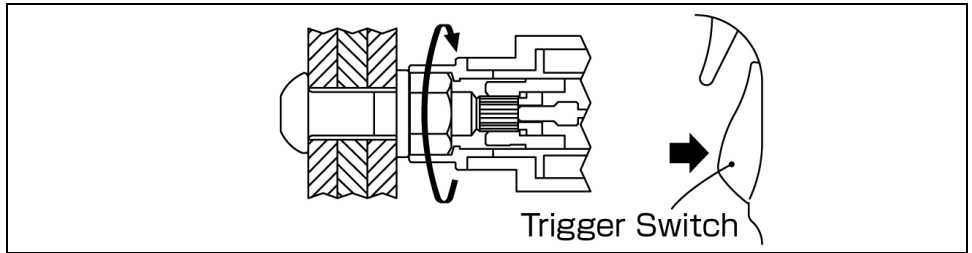

(4) Rotating speed gradually slows down as the tightening proceeds, then bolt pintail shears off when designated torque is reached (Figure 5).

(Figure 5)

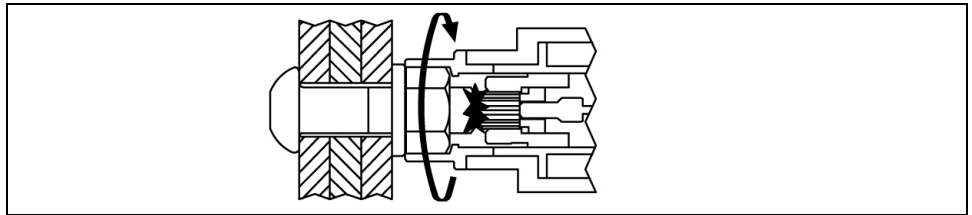

(5) When tightening is completed, remove wrench from bolt/nut assembly. Sheared-off bolt pintail remains in Inner Socket (Figure 6).

(Figure 6)

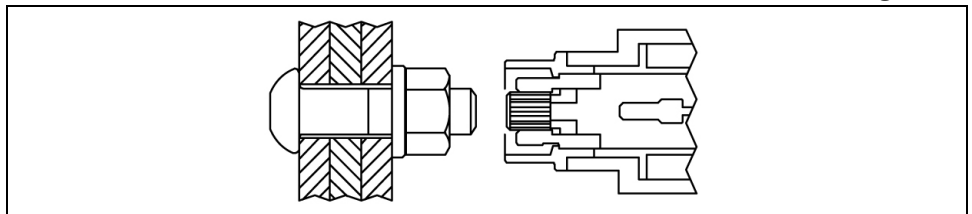

(6) Pull Ejector Lever to eject bolt pintail (Figure 7).
Keep pintail in designated bag.

(Figure 7)

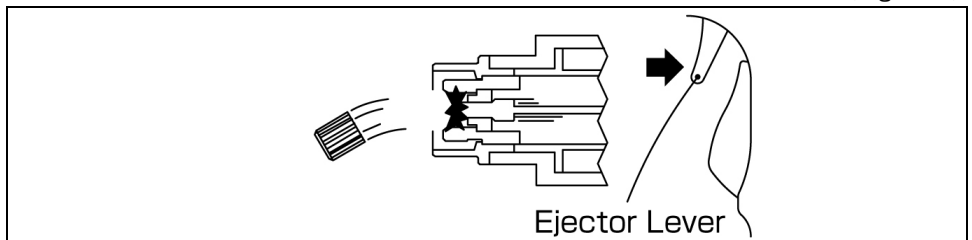

WARNING

- Keep others a safe distance from work area.
- Do not throw pintail away. Collect pintail in designate bag during operation.

Failure to follow this instruction may result in accidents and personal injury.

8. CHANGING SOCKETS

WARNING

- Release ejector pin by pulling ejector lever before changing sockets.

Accidental ejector pin release invites blindness or injury.

- (1) Remove inner & outer socket assembly from wrench by unscrewing set screws (Figure 8). Do not remove set screws completely from outer socket holder.

(Figure 8)

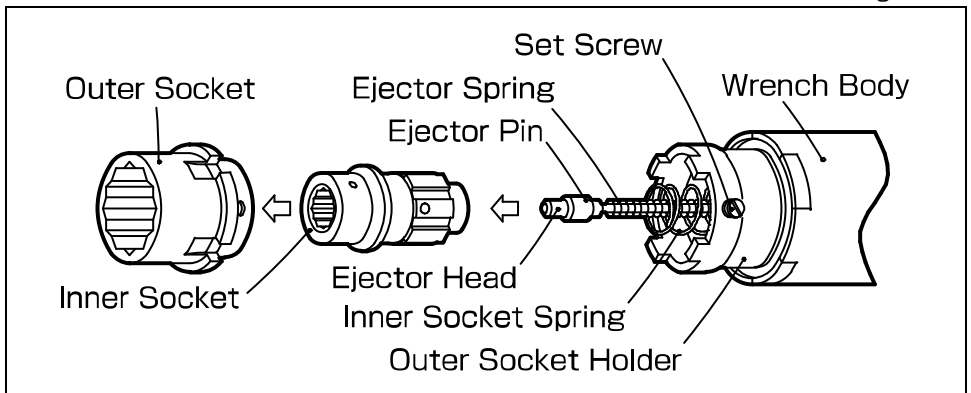

(2) Prepare outer and inner-sockets of the right sizes suitable for the size of bolt to be tightened.

...Example : Use our standard socket for 3/4" to 3/4" bolts.

(3) As per (Figure 9), firstly install inner socket onto ejector-pin on the main body and then, install outer-socket into inner-socket.

(Figure 9)

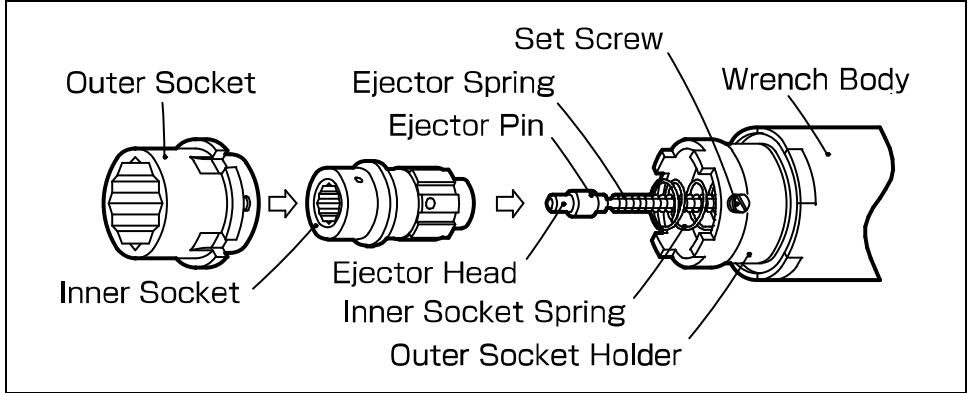

(4) There might be the case that perfect installation is not obtainable due to a gap between main body and outer-socket, as shown per (Figure 10).

(Figure 10)

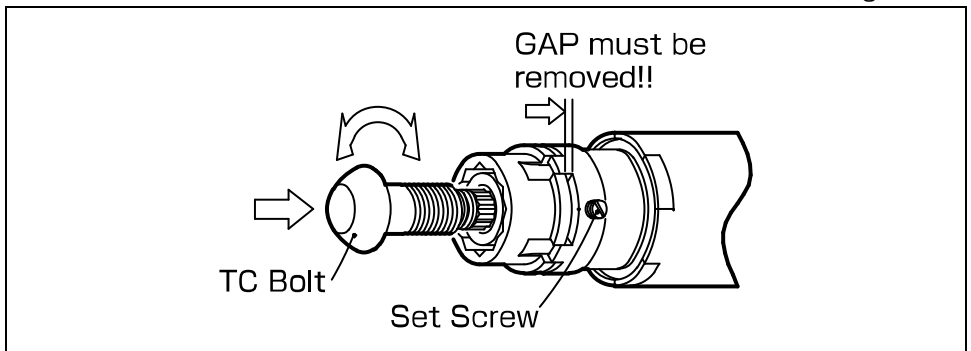

WARNING

- There should be no gap between the socket assembly and the wrench.

The gap invites accidents or breakage of the sockets or the wrench body.

9. INSPECTION & MAINTENANCE

WARNING

- **Disconnect plug from power source before inspection and maintenance.**

- Accidental starting invites serious injury.

- **Replace the inner socket when sheared bolt pintail is came off the inner socket without pulling the ejector lever.**

- There is a risk of unexpected bolt pintail ejection when inner drive of the inner socket is worn down. The inner socket must be immediately replaced.

Failure to follow this instruction may result in serious accidents and injury.

- (1) Clean dust and debris from the sockets periodically.
- (2) Use only a damp cloth to clean your wrench and sockets since certain cleaning agents and solvents are harmful to those parts. Some of these include: benzene, thinner, gasoline and etc.
- (3) Never put solvents into the exhaust vent.
- (4) Store wrench in the metal case after operation and keep it dry.
- (5) Ejector pin must be regularly inspected and replaced when it wears down. Sheared bolt pintail will not be ejected from inner socket with worn ejector pin.

(6) Carbon brush must be regularly inspected and replaced with the new genuine carbon brush when brush length becomes less than 5mm (Figure 11).

*Carbon brushes are placed in two positions.

*Indicate the wrench model when carbon brushes are needed because carbon brush differs from model to model.

(Figure 11)

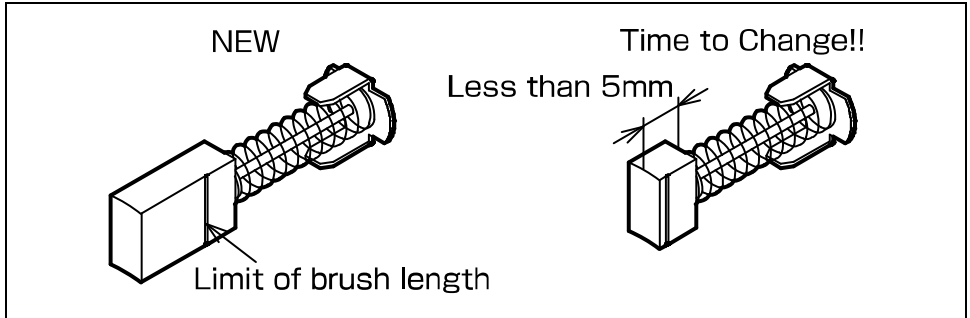

(7) Replace carbon brush as shown in the following figure 12.

(Figure 12)

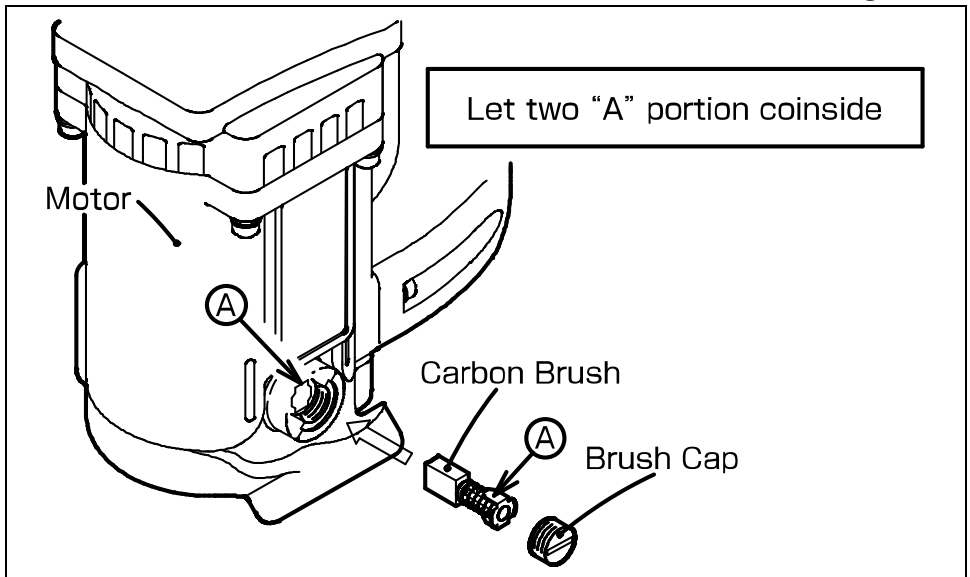

(8) Overhaul must be carried out every 6 months or 30,000 tightening, whichever comes first. Contact your distributor for overhaul.

10. SPECIFICATIONS

Model	GS-91EZ	GS-92EZ	GS-111EZ	GS-112EZ
Frequency	50-60 Hz			
Voltage (Single Phase)	110-120 V	220-230 V	110-120 V	220-230 V
Max Current	17A	8.5A	19A	9.5A
Rated Power	1750W		2000W	
Intermittent Operation	2s / 3s			
Rated Max Torque	810 lbf.ft (1100 N·m)		1030 lbf.ft (1400 N·m)	
Rated No-load Speed	17min ⁻¹ (rpm)		15min ⁻¹ (rpm)	
Noise & Vibration Level	Sound Pressure Level 84 dB(A) Sound Power Level 95 dB(A) Vibration Level 2.5 m/s ² or below			
Adaptable Bolt Dia.	A325	1", 7/8", 3/4", 5/8"		1-1/8", 1", 7/8", 3/4"
	A490	1", 7/8", 3/4", 5/8"		1-1/8", 1", 7/8", 3/4"
Weight	7.6kg		8.7kg	
Insulation Class	Class II (Double Insulation)			

- Weight excludes socket & cord.

11. AFTER SALES SERVICE

- Contact your distributor for available services.
- Provide model, serial number, date of purchase and details of failure when contacting your distributor.



CAUTION

- Do not use wrench when malfunction, deficiency in wrenches' performance, personal injury or property loss is foreseen.

If possible, prepare backup wrenches beforehand.



TONE CO., LTD.

1-57, MINATOMACHI 2-CHOME,
NANIWA-KU, OSAKA 556-0017, JAPAN,

Web Site: <http://www.tonetool.co.jp>
e-mail: overseas@tonetool.co.jp

● Specifications and the design are subject to change without notice. ●